

1

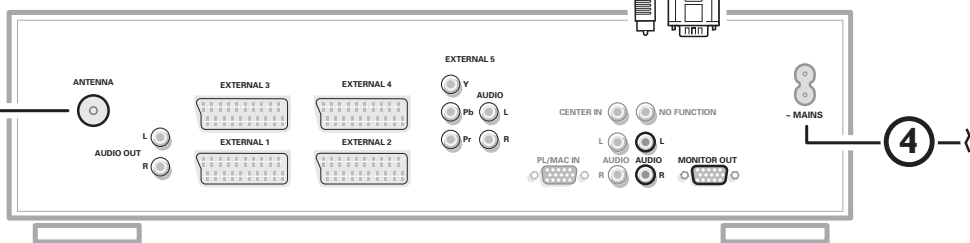

Contents

Remark :

The featuring dealt with in this instruction manual does not necessarily match with your type of TV.

Installation

- Your remote control **2**
- Preparation **3-4**
- To use the menus and the menu system **4**
- Select the menu language **5**
- Select the country **5**
- Store TV channels
 - Automatic installation **6**
 - Manual installation **6**
 - Give name **6**
 - Reshuffle the programme list **6**
 - Select Favourite TV channels **6**
- Select TV setup **7-9**

Operation

- Use of the remote control **10-12**
- Keys in front of the TV receiver box **12**
- TV menu
 - Picture menu **13-14**
 - Sound menu **14-15**
 - Features menu **16-17**
- Dual screen/PIP (FTR 9964 only) **18**
- Multipip (FTR 9964 only) **19**
- Teletext Guide **20**
- Teletext **21-23**

Connect Peripheral Equipment

- Connecting and selecting equipment **24-27**
- Remote Control functions for peripherals **28-29**
- Recording **30**

- Tips 31**
- Index 31**
- Glossary 32**

Help?

If this instruction manual does not give an answer or if 'Tips' do not solve your TV problem, you can call your Local Philips Customer or Service Centre. See the supplied World-wide guarantee booklet.

Please, have the Model and Product number which you can find at the back of your television set or on the packaging, ready, before calling the Philips helpline.

Model:

Product No:

Installation

Your remote control

➔ Peripherals p. 27

Source selection of **EXT1, EXT2, EXT3, EXT4, EXT5, FRONT, VGA** or TV channels

Mode keys p. 10

TV, VCR, DVD, SAT, TAPE, CD, TUNER or **CDR** selection

12 Dual screen/PIP on/off p. 18
(FTR 9964 only)

Freeze format on/off p. 10
(FTR 9964 only)

Cinema Link
See separate instruction manual

Teletext Guide on/off p. 20

OK Activate your choice p. 10

Volume Up/Down p. 10

Sound mute p. 10

P Programme selection p. 10

Screen information p. 10

PxP Smart surf key p. 11

-/- Video recorder function p. 28

Surround mode p. 11

EasyLink - instant recording p. 11

Picture format p. 11

Switch to standby p. 10

Colour keys

- direct teletext page or subject selection p. 21
- basic functions selection in Teletext Guide p. 20

Audio- and Video equipment
p. 28-29

Teletext on/off p. 21

Main menu on/off p. 4

Cursor to select your choice

Time display p. 11

Multipip on/off p. 19 (FTR 9964 only)

Enlarge in TXT p. 22

Zoom on/off p. 11

Swapping screens p. 18 (FTR 9964 only)

Smart Controls

Smart sound p. 12

Active control p. 12

Smart picture p. 12

Preparation

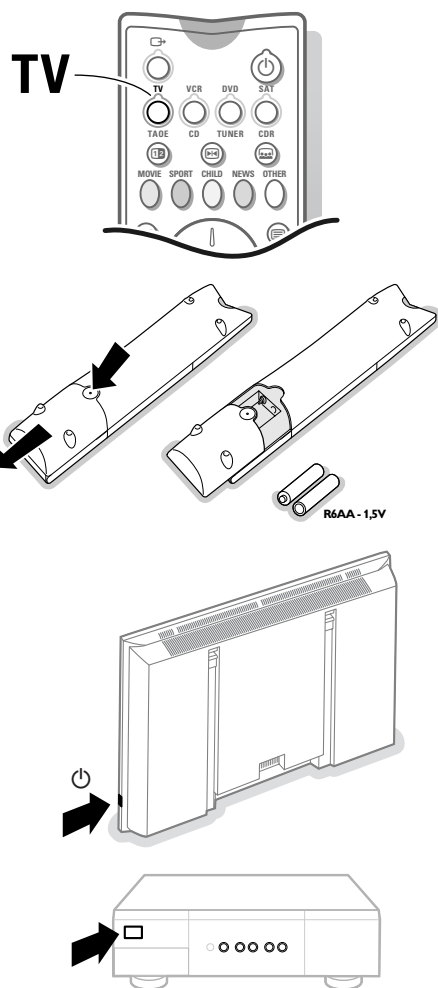
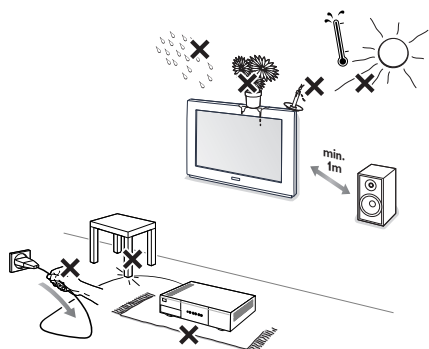

- 1 Place the receiver box wherever you want, but make sure that air can circulate freely through the ventilation slots. Do not install the receiver box in a confined space such as a book case or a similar unit. To prevent any unsafe situations, no naked flame sources, such as lighted candles, should be placed on or in the vicinity. Avoid heat, direct sunlight and exposure to rain or water. The equipment shall not be exposed to dripping or splashing and no objects filled with liquids, such as vases, shall be placed on it.
- 2 Connect the **supplied** aerial cable ① and the **VGA** cable with trailing audio cinch connectors ② as shown in the inside frontcover of this handbook. Make sure all screws of the cable ② are tightened well.

TV receiver box with speakerless monitor

In case you connect your TV receiver box with a speakerless monitor, and without having connected an audio receiver, all references made in this instruction book to sound reproduction, volume control, and audio connections, are not applicable (except for a headphone connection). The keys on the remote control referring to sound have no function either.

- 3 To connect your computer, see the separate supplied instruction manual with your monitor. To connect other peripherals, see p. 24. If you dispose of a Cinema Link combination (Cinema Link Audio receiver and/or Cinema Link video recorder and/or DVD player), see the separate supplied instruction manual. In order to obtain the best result, please use only the supplied antenna cables between the receiver box and videorecorder, and between videorecorder and antenna connector.
- 4 Insert the mains cord supplied ③ into the **MAINS** at the back of the monitor and the mains cord ④ at the back of the receiver. Put both in the wall sockets.
- 5 Remote control: Remove the cover of the battery compartment. Insert the 2 batteries supplied (Type R6AA-1.5V). Press the **TV** key to be sure your remote control is in the TV mode. *The batteries supplied do not contain the heavy metals mercury and cadmium. Nevertheless in many countries batteries may not be disposed of with your household waste. Please check on how to dispose of batteries according to local regulations.*
- 6 **Switch the TV on :** Press the power key  at the right side of the monitor and the one on the front of the receiver box. A green indicator lights up both on the monitor and on the receiver box and the screen comes on. If the indicator is red, press the **-P+** key or one of the digit keys on the remote control.

*The green indicator blinks every time you press a key on the remote control. When you switch on your set **for the first time**, the menu **LANGUAGE** automatically appears on the screen. The explanation appears in different languages one at a time. Follow the instructions on screen.*

To use the menus and the menu system

Attention: point the remote control to the indicator of the monitor.

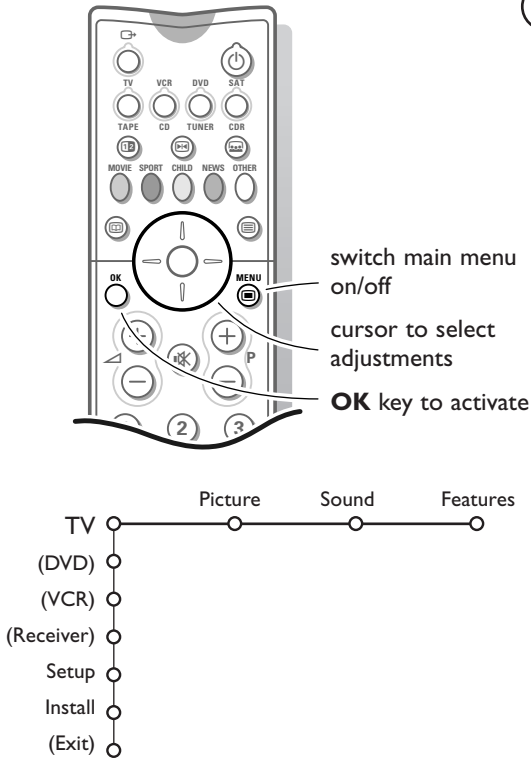

- 1 Press the **MENU** key on the remote control to summon the main menu. Which items appear in the main menu depends on the peripherals connected. In case of an EasyLink VCR the menu item **VCR** is present, see p. 24. In case of a Cinema Link audio receiver the menu item **Receiver** is present. See the separate Cinema Link booklet supplied.

Note: The Main menu contains the item **Exit** to dismiss the menu, only when you switch on your TV for the first time, or when the Main menu is summoned with the **MENU** key in front of the TV receiver.

- 2 Use the cursor in the up/down direction to select the **TV**, **(DVD)**, **(VCR)**, **(Receiver)**, **Setup** or **Install** menu.

Note: Sometimes not all the menu items are visible on the screen. Press the cursor down to reveal all items.

- 3 Use the cursor in the left/right direction to select the menu item.

- 4 Use the cursor up/down again to select the control you want to select or to adjust. For instance, see Picture menu.

- 5 Press the **MENU** key again to turn off the main menu.

The menu system

Pipes, balls and a puck

The hierarchy of menus and controls is represented by an animated visual mechanism of pipes, balls and a puck. The animated mechanism constantly shows the current whereabouts and continually expands the view of the immediate neighbourhood.

The puck surrounds the ball indicating the user's current position in the menu hierarchy.

The puck is always present when the menu system is displayed.

The puck is divided into 4 parts. They correspond to the directional controls (up/down, left/right) on the remote control. The arrows on the cursor indicate which directions to choose.

In this way users can navigate through the menu hierarchy to the control they wish to adjust.

When items are more numerous than can fit comfortably on the TV display, only a portion are shown. Those omitted are indicated by a cluster of balls which indicates that there are 'more' items.

Direct selection and control

Menu items are controlled as soon as they are selected by the puck. Only a few items require confirmation with the **OK** key.

List controls

A list control is used to select one or more items from a list of options. For instance, the Picture format option list with 4:3, Movie Expand 14:9, etc. Press the right key to move the puck into the list. At least one item is the current value and is highlighted.

Moving the puck up or down with the up/down key causes the list to move down or up.

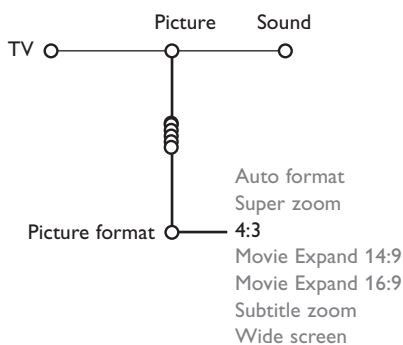
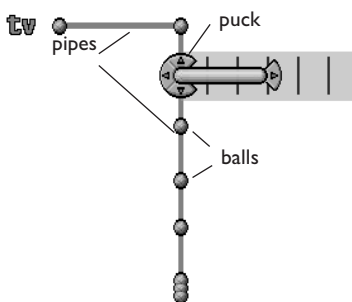

Select the menu language

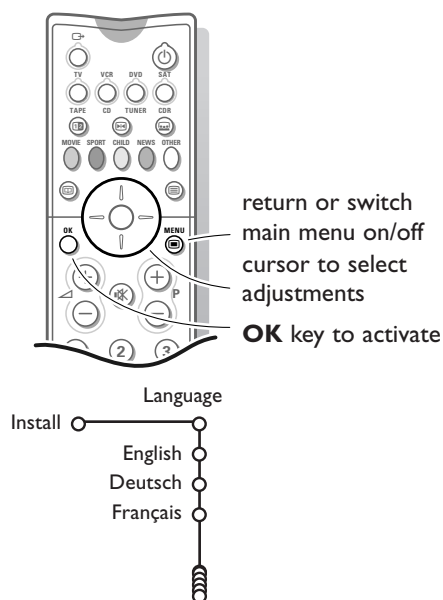

- 1 Press the **MENU** key on the remote control.

When you switch on your TV for the first time and no channels are stored so far, the menu **Language** automatically appears on the screen. This menu also has an additional item **Exit** with which the menu can be dismissed. The explanation appears in different languages, one at a time. Choose your preferred language and press the **OK** key on the remote control. Proceed with the **Install** menu.

- 2 Use the cursor down to select **Install**.
- 3 Use the cursor right to select **Language**. Follow the instructions on screen.
- 4 Use the cursor up/down to select your preferred language and press the **OK** key to confirm your selection.
- 5 Proceed with the **Install** menu.

Select the country

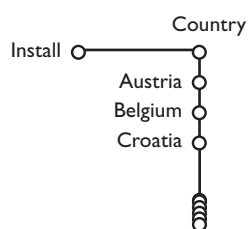

- 1 Use the cursor right to select **Country**.
- 2 Select the country where you are now located and press the **OK** key. Select **Other** when none of the countries applies.
- 3 Proceed with the **Install** menu.

Store TV channels

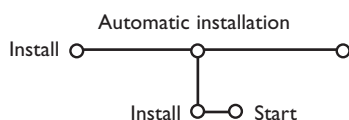

You can now search for and store the TV channels in two different ways: using **Automatic Installation** or **Manual Installation** (tuning-in channel by channel). Select your choice with the cursor right.

After the new or extra TV channels have been stored, the TV automatically transfers those TV channels to the video recorder if it is equipped with the **EasyLink** function. The message **EasyLink: downloading** appears on the screen. The programme list of the video recorder is now the same as the one of the TV.

Automatic installation

- 1 Select **Automatic installation** in the **Install** menu.
Note: All channels must be unlocked in order to autoprogram. If requested, enter your code to unlock all channels. (See TV, Features menu, Childlock, p. 16.)
- 2 Press the cursor down.
The autoprogramming option label **Start** appears.
- 3 Press the cursor right.
- 4 The message **Searching** appears and the progress of autoprogramming is displayed.
When the Automatic installation is complete, the puck navigates to **Install** again.

If a cable system or a TV channel which broadcasts **ACI** (Automatic Channel Installation) is detected, the search is stopped and the programme list appears. Without **ACI** broadcast, the channels are numbered according your language and country selection. You can use **Reshuffle** to renumber them. See p. 6.

It is possible that the cable company or the TV channel displays a broadcast selection menu. Layout and items are defined by the cable company or the TV channel. Make your choice with the cursor and press the **OK** key.

Manual installation

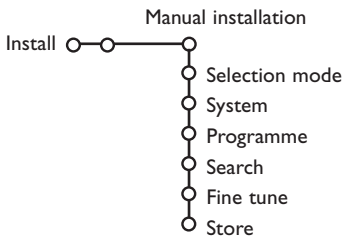

Searching for and storing TV channels is done channel by channel. You **must go through every step** of the Manual Installation menu.

- 1 Select **Manual installation** in the Install menu.
- 2 Press the cursor down.
Follow the instructions on screen.

Note: Search or direct selection of a TV channel

If you know the frequency, the C- or S-channel number, enter the 3 digits of the frequency directly with the digit keys 0 to 9 (e.g. 048). Press the cursor down to proceed.

Repeat to search for another TV channel.

Give name

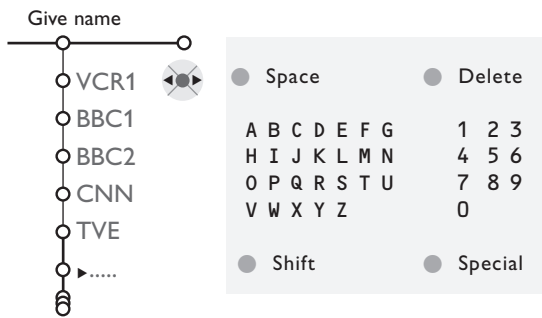

It is possible to change the name stored in the memory or to assign a name to a TV channel for which a name has not yet been entered. A name with up to 5 letters or numbers can be given to the programme numbers 0 to 99. For example SUPER, BBC1,... Before programme number 0 you can also enter a name for the peripherals that are connected to a euroconnector.

Note: it is not possible to rename the VGA source.

- 1 Select **Give Name** in the Install menu and press the cursor down.
- 2 Select the programme number.
Note: keep the cursor up/down pressed to scroll through the programme list and to avoid that the TV tunes to each channel passed by.
- 3 Press the cursor right.
A keyboard appears on the screen.
Press the cursor right to enter the keyboard.
Press the cursor up/down, left/right to select the first character and press **OK**. Repeat for every character you want to enter.
Select **Space** to enter a space; **Delete** to erase the highlighted character in the name entered; **Shift** to display upper- or undercast characters on the keyboard; **Special** to display special characters on the keyboard. Press **OK** to confirm.
- 4 Press the cursor left repeatedly when you have finished the name giving of the selected channel or peripheral.
- 5 Select another programme number and repeat steps 3 to 4.

Reshuffle the programme list

According to your preference you **can** change the order of the stored TV channels.

- 1 Select **Reshuffle** in the **INSTALLATION** menu.
- 2 Follow the instructions on screen.

Select Favourite TV channels

A VGA source always belongs to the list of Favourite programmes.

- 1 Select **Favourite programmes** in the **Install** menu.
- 2 Select your programme number with the cursor up/down.
- 3 Select **Yes** or **No** with the cursor right.
- 4 Repeat 2 and 3 for every TV channel or external you want to make a favourite or a non-favourite TV channel or external.

Select TV setup

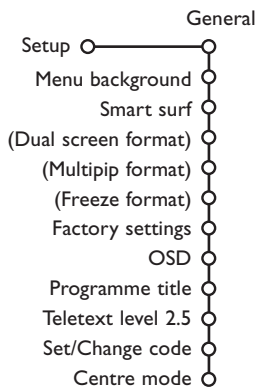

The Setup menu allows you to adjust initial settings, i.e. those which are not related to the installation of the TV channels. The Setup menu contains items that control the settings of the TV's functions, features, services and peripherals you may have connected.

General

This menu allows you to change various settings that are presumably adjusted less frequently than most other settings.

Menu Background

- 1 Select **Menu Background** with the cursor down.
- 2 Press the cursor right.
- 3 Select **On** or **Off** to turn the Menu Background on or off.

Smart surf

- 1 Select **Smart surf** with the cursor down.
- 2 Select **2 programmes** or **9 programmes** with the cursor right.

Select **2 programmes** if you want the P+P key to toggle between the current and the previously selected channel. Select **9 programmes** if you want the P+P key to summon a list of up to 9 channels which can be selected. (See Use of the Remote Control, p. 11.)

Dual screen format *(FTR 9964 only)*

This menu allows you to select the preferred format which can then be displayed toggling the **12** key on and off.

See Dual screen/PIP, p. 18.

Select **Dual screen**, **Large PIP**, **Medium PIP** or **Small PIP** with the cursor down.

When Dual screen mode is activated with the remote control **12** key, and when:

- **Dual screen** is selected, the TV splits the screen into two equally sized screens.
- **PIP** is selected, the TV shows a full screen of video with a pip window of video on top if it.

Multipip format *(FTR 9964 only)*

This menu allows you to select the preferred format which can then be displayed toggling the **13** key on and off.

Select **PIP3**, **PIP8** or **PIP12** with the cursor down.

See Multipip, p. 19 how to operate.

Freeze format *(FTR 9964 only)*

This function is not possible with a VGA source.

Freeze format allows you to select among three options: Freeze, Replay, Photo finish, to be activated when you press the **14** key on the remote control.

See p. 10.

*Note: Continuing to hold the **14** key down will also cycle the TV through the various formats. Changing the format this way does not store the selected format.*

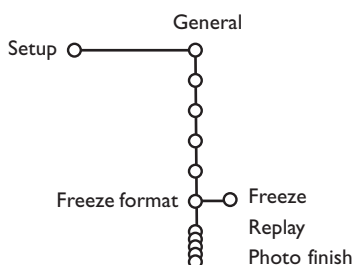
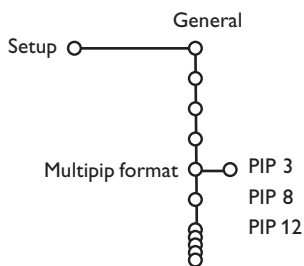
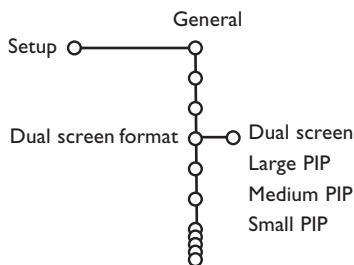
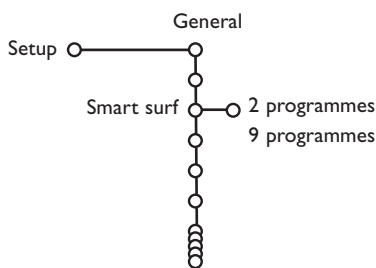

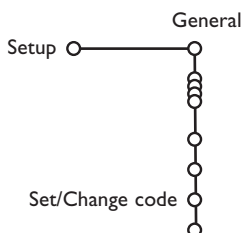
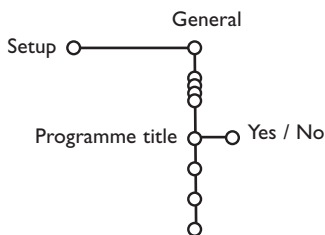
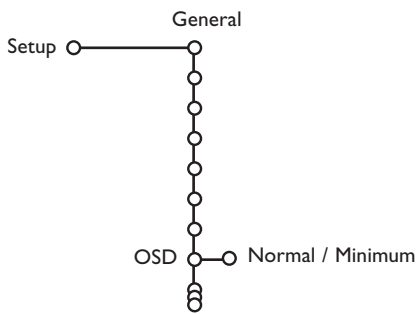

Factory settings

This function allows you to reset most of the picture and sound settings to their predefined factory values.

- 1 Select **Factory settings** with the cursor down.
- 2 Press **OK** to erase settings and reset them to their default values.

OSD (On Screen Display)

- 1 Select **OSD** with the cursor down.
- 2 Press the cursor right to select **Normal** or **Minimum**.
Normal to activate extended display of TV channel and programme information on screen.
Minimum to activate the display of reduced channel information. See Use of the Remote Control, p. 10, **i+** On screen information.

Note: When Subtitles is switched on, see Features, p. 16, display of the programme number is not possible.

Programme title

- 1 Select **Programme title** with the cursor down.
- 2 Press the cursor right to select **Programme title Yes** or **No**.
When selected **Yes**, after the selection of a TV programme or after pressing the **i+** key on the remote control, a TV channel which broadcasts teletext may transmit the name of the TV channel or the programme title.
When selected **No**, the programme title will only appear after pressing the **i+** key, and not after the selection of a TV channel.

Set/Change code

The Child lock feature (see TV, Features, p. 16) allows you to lock channels to prevent children from watching certain programmes.

To watch locked channels, you need to enter an access code.

The Set/Change code menu item allows you to create or change a Personal Identification Number (PIN).

- 1 Select **Set/Change code** with the cursor down.
- 2 If no code exists yet, the menu item is set to **Set code**. Follow the instructions on screen.
If a code has previously been entered, the menu item is set to **Change code**. Follow the instructions on screen.
All number combinations from 0000 to 9999 are valid numbers.
- 3 The General menu reappears with a message confirming that the code has been created.

Important: You have forgotten your code !

- 1 Select **Set/Change code** in the General menu.
- 2 Press **OK**.
- 3 Press the cursor right.
- 4 Enter the overriding code 8-8-8-8.
- 5 Press the cursor again and enter a new personal 4-digit code.
The previous code is erased and the new code is stored.

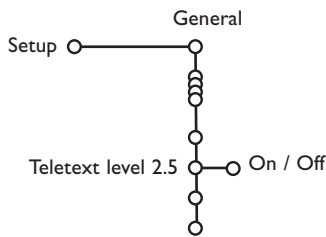

Teletext level 2.5

Some broadcasters offer the opportunity to see more colours, other background colours and nicer pictures in the teletext pages.

- 1 Select **Teletext level 2.5** with the cursor down.
- 2 Press the cursor right to select **Teletext level 2.5 On** to take advantage of this feature.
- 3 Press the cursor right again to select **Teletext level 2.5 Off** if you like the more neutral teletext layout.
The selection made is valid for all channels which broadcast teletext.

Note: It may take a few seconds before teletext broadcast switches over to Teletext level 2.5.

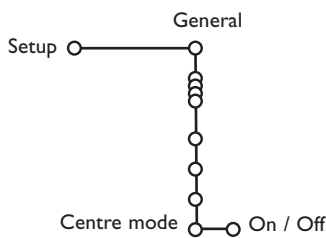

Centre mode

When you have connected a multi channel audio receiver to the receiver box (see Connect peripheral equipment, p. 26) and you have selected **Centre mode On**, the loudspeakers of the monitor will act as centre speaker, making a separate centre speaker unnecessary.

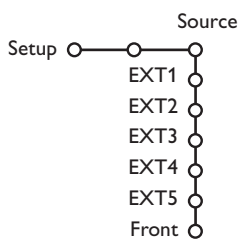

Source

This menu allows you to select the peripheral you connected to one of the external inputs.

- 1 Select **Source** with the cursor right.
- 2 Press the cursor down to select one of the external inputs.
- 3 Press the cursor right to enter the list of types of peripherals attached to the selected input.
- 4 Select the peripheral device with the cursor up/down.

Once you have selected the source, e.g. VCR, this source will automatically be selected when your remote control is in VCR mode, see p. 10, and you press the  key on the remote control.

Decoder

If a decoder or a descrambler is connected, see p. 24, you can define one or more programme numbers as decoder programme numbers.

- 1 Select **Decoder** with the cursor right.
- 2 Select **Programme** with the cursor down.
- 3 Select the programme number under which you have stored the programme coming from your decoder.
- 4 Select **Status**.
 - Select the input used to connect your decoder: **None, EXT1, EXT2**.
 - Select **None** if you do not want the selected programme number being activated as a decoder programme number.

Operation

Use of the remote control

Select your computer or other peripherals

Press this key repeatedly to select **EXT1**, **EXT2**, **EXT3**, **EXT4**, **EXT5**, **FRONT**, **VGA** or **TV** channels, according to where you connected your peripherals (see p. 27).

Remark: in **VGA** mode only some keys are valid. See **VGA** menu, p. 27. Menus and on screen information will disappear if you select **VGA**.

TV VCR DVD SAT TAPE CD TUNER CDR

Press one of these keys to use the remote control directly in the TV, video recorder, DVD or satellite mode. A green indicator lights up. Press the same key again within 3 seconds to use the remote control in the mode indicated below the key (tape, CD, tuner or CD-recordable). A red indicator lights up. Press the key again within 3 seconds to return to the function named above the key.

Teletext Guide on/off see p. 20

OK Press this key to activate your choice, when in the menus.

Volume

Press + or - to adjust the volume.

Sound Mute

Temporarily interrupt the sound or restore it.

P Programme selection

To browse through the TV channels and sources stored.

Only those channels which are in the favourite list can be selected with the **-P+** keys. See p.6.

0/9 Digit keys

To select a TV channel.

For a two digit channel number, enter the second digit within 2 seconds.

To switch immediately to a selected one digit TV channel, keep the digit key pressed a bit longer.

Screen information

Press to display information about the selected TV channel and programme.

Standby

The set is switched off and the red indicator lights up.

To switch the TV on again, press **- P +** or the digit keys.

If your EasyLink video recorder has the system standby function and you press the standby key for 3 seconds, both the TV and video recorder are switched to standby.

Dual screen/PIP on/off (FTR 9964 only)

See Setup, General menu, p. 7, and Dual screen/PIP, p. 18.

Freeze



Press the  key to activate/de-activate a frozen picture.



Freeze format on/off (FTR 9964 only)

This function is not available with a VGA source.

See Setup menu, General, Freeze format, p. 8 where you can select among three modes to be displayed when the freeze key is pressed on the remote control: Freeze, Replay, Photo finish.

When the mode is **Freeze**: press the  key to activate/de-activate a frozen picture. The audio continues to play.

When the mode is **Replay**: press the  key to redisplay a few seconds of stored video in a PIP window. Press the **OK** key to display a few seconds of a new stored video picture. Press the  key again to switch off.

When the mode is **Photo finish**: press the  key to display 12 PIP windows of stored video pictures. Press the **OK** key to display a new series of frozen pictures. Press the  key again to switch off.

Note: Continuing to hold the  key down will cycle the TV through the various modes (Freeze, Replay, Photo Finish).

Cinema Go

See separate Cinema Link instruction manual supplied.

Teletext on/off see p. 21

Main menu on/off see p. 4

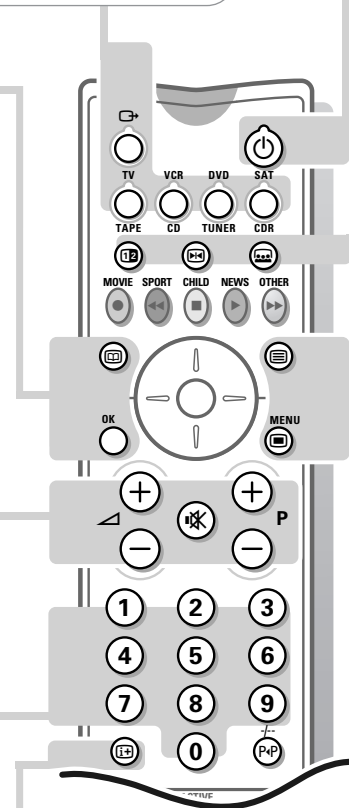

Surround mode on/off

- In **MONO** sound mode, this feature, when switched on, enables you to hear a special effect of sound.
- In **STEREO** sound mode, when **Surround mode** is switched on, it seems as though the loudspeakers are spread further apart from one another.

Instant record

If your video recorder has the EasyLink function, the **INSTANT**  key for record can be operated in the TV mode.

Picture format

Press this key to summon a list of **available** picture formats.



Press this key repeatedly or press the cursor up/down to select another picture format:

Auto format, Super zoom, 4:3, Movie Expand 14:9, Movie Expand 16:9, Subtitle zoom, Wide screen.

Auto format makes the picture fill the screen as much as possible.

In case of subtitles in the bottom black bar, Auto format makes the subtitles visible. In case of a broadcaster logo in the corner of the top black bar, the logo disappears from the screen.

Super zoom removes the black bars on the sides of 4:3 programs with minimal distortion. When in Movie Expand 14:9, 16:9 or Super zoom picture format, you can make subtitles visible with the cursor up/down.

Note: In VGA mode press the  key to switch between a 4:3 or a Wide screen picture format. In Dual screen mode press the  key to switch between a full or a 4:3 letterbox picture format.

Swapping screens in Dual screen or PIP (FTR 9964 only)

See Setup, General menu, p. 8 and Dual screen/PIP, p. 18.

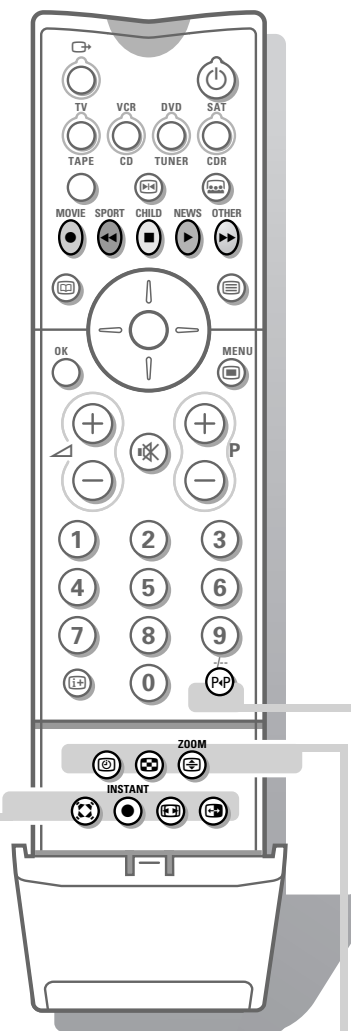

PiP Smart surf

With this feature you can easily switch between different TV channels/sources that currently interest you.

In the menu system, you can set Smart surf to 2- or 9-programme.

(See General, Smart surf, p. 7.)

Press this key to select the previously viewed TV channel or source in case of a 2 programme surf, or to select the surf ring in case of a 9 programme surf.

In case of a 9 programme surf, a list appears at the right side of the screen. On top, the most recently added. The puck is on the channel number currently viewed.

Press the PIP key to turn to the next channel in the list or press cursor up/down to immediately select the desired TV channel of the list.

To add a new channel or source: tune to the channel or source you wish to add.

Press the PIP key. Press the cursor right to add.

If there are already nine channels/sources in the list, the one at the bottom of the list will be removed.

To remove a channel or source: select the channel number you want to remove. Press the PIP key. Press the cursor right to remove.

Press the **OK** key or wait for the time out to dismiss the Smart surf display.

Time display on/off

The time is displayed on the screen.

Multipip (FTR 9964 only)

Press  to turn on/off Multipip.

The Multipip format that launches on the key press is determined by the selection you made in the Multipip format list in the General menu, see Setup, General, p. 8 and Multipip format, p. 19.

Note: Continuing to hold the  key down will cycle the TV through the various formats (PIP3, PIP8, PIP12), launching a new format after each second the key is held down. Changing the format this way does not store the selected format.

Press the  key again to return to a full main screen picture.

ZOOM on/off

Press the **ZOOM**  key to activate/ deactivate the zoom function.

Press the **OK** key repeatedly to select one of the zoom magnifications (x1, x4, x9, x16). Use the cursor up/down, left/right to shift the selected zoom window over the screen with the cursor.

The zoom window is reset after: selecting another TV channel, another picture format or when another picture format is selected automatically.

Zooming is disabled in Dual screen and VGA mode.

Active Control

Active Control is a pro-active and automatic system. The TV continuously measures and corrects all incoming signals in order to provide the best picture possible.

According to the monitor connected (with or without an Ambient Light Sensor which measures the light conditions of the room), the Active Control functionality may differ.

With a monitor without a light sensor:

Press the  key to select the the Active Control values **Off** or **On**.

With a monitor with a light sensor:

Press the  key repeatedly to select the Active Control values **Off**, **Minimum**, **Medium** or **Maximum** (recommended)

Minimum/On Sharpness, Dynamic Contrast and Noise Reduction are controlled automatically

Medium Sharpness, Colour, Dynamic Contrast and Noise Reduction are controlled automatically

Maximum Sharpness, Colour, Contrast, Dynamic Contrast and Noise Reduction are controlled automatically

Press the cursor in the right direction to select **INFO**.

The Active Control Demo appears.

The picture settings are being adapted continuously and automatically.

The sliders will be moving, showing how the TV is tweaking the current picture.

None of the sliders is user controllable.

Press the **OK** key to switch off the Demo.

Note: Active Control is not available for digital HD signals.

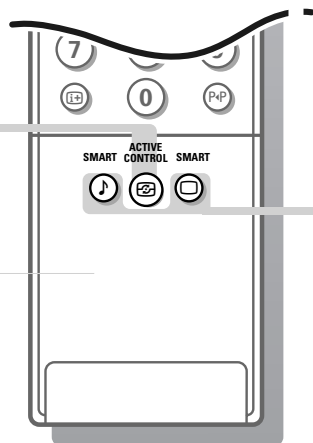

Smart keys

To select predefined picture and sound settings.

Note: The Smart keys are disabled when a VGA source is being displayed.

Sound

Each time it is pressed, a different sound setting is selected, corresponding with specific factory setting of bass and treble.

Picture

Each time it is pressed, a different picture setting is selected, corresponding with specific factory settings of Contrast, Colour, Sharpness, Colour Enhancement, DNR and Dynamic Contrast.

Personal refers to the personal preference settings of picture and sound selected in the picture and sound menu.

*Remark: the moment you are in a predefined smart sound or picture setting and you modify a setting in the picture or sound menu, all values of the menu will overwrite the previously made **Personal** settings. The predefined factory settings remain unchanged.*

Keys in front of the TV receiver box

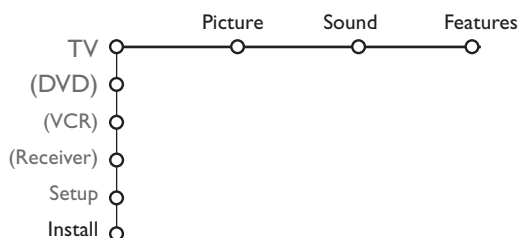
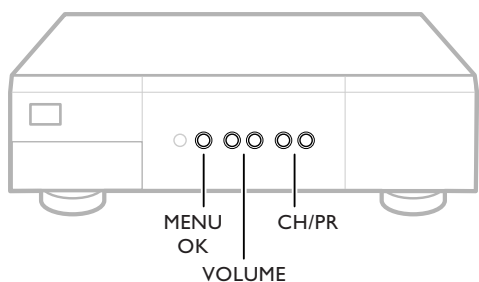

Should your remote be lost or broken you can still use the keys in front of the TV receiver box.

- Press the **VOLUME** - or + key to adjust the chosen volume.
- Press the **CH/PR** - and + key to browse through the TV channels or sources stored and to select them.
- Press the **MENU** key to summon the main menu. Use the **VOLUME** - and + keys to select the menu item. Use the **CH/PR** - and + keys to select the **TV**, **(DVD)**, **(VCR)**, **(Receiver)**, **Setup**, **Install** menu or **Exit**, or to select the submenu items.

Note:

- Sometimes not all the menu items are visible on the screen;

Press the **CH/PR** + key to reveal all items.

- The **Exit** menu lets you dismiss the menu. Select **Exit** and press the **MENU** key.

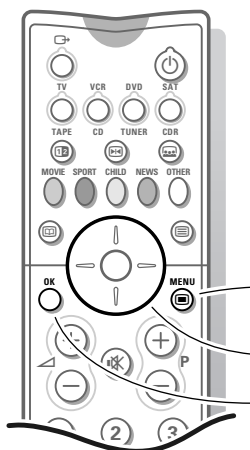

switch main menu on/off

cursor to select adjustments

OK key to activate



TV menu

Press the **MENU** key on the remote control to summon the main menu.

Note: When the main menu is accessed from the keypad in front of the TV receiver box, it has an additional Exit item, which lets you dismiss the menu.

Warning: The main menu is completely different when a VGA source is displayed. See p. 27.

Picture menu

Press the cursor right to select **Picture**.

Select the menu items in the Picture menu with the cursor up/down.

Adjust the settings with the cursor left/right or enter the list of submenu items with the cursor right.

Select a submenu item with the cursor up/down.

Note: To remove the menu background before adjusting the picture settings, see Select TV setup, General, p. 7.

Contrast

This control allows you to adjust the contrast level of the picture.

Brightness

This control allows you to adjust the brightness level of the picture.

Colour

This control allows you to adjust the colour saturation of the picture.

Sharpness

This control allows you to adjust the edge definition of a picture.

Tint

This control allows you to select the colour temperature of the picture:

Normal, **Warm** or **Cool**.

Digital natural motion

Line doubling eliminates line flicker; motion compensation reduces jitter and offers smooth, yet sharp motion reproduction in movie broadcasts.

Select **On** or **Off** to really see the difference in picture quality.

Dynamic Contrast

This feature automatically makes the contrast in the darker and the brighter picture areas more noticeable as the image on screen changes.

Normally, select **Medium**. It may be preferred to select **Minimum**, **Maximum** or **Off**.

DNR (Digital Noise Reduction)

This feature automatically filters out and reduces the image noise and improves picture quality when receiving weak video signals.

Select **Off**, **Minimum**, **Medium** or **Maximum** according to the image noise present.



Colour enhancement

When activated, this feature automatically controls green enhancement and blue stretch. It makes the colours more vivid. Select **On** or **Off** in order to activate/de-activate Colour Enhancement with the cursor right.

Hue (only available when a NTSC peripheral is connected)

This control allows you to adjust the colour mix of the picture.

Smart picture

This menu item performs the same as the Smart key on the remote control. See Use of the remote control, p. 12.

Smart settings will be set to **Personal** if the following settings are changed manually: contrast, brightness, colour, sharpness, dynamic contrast, colour enhancement or DNR.

Picture format

This menu item performs the same as the  key on the Remote Control. See Use of the Remote Control, p. 11.

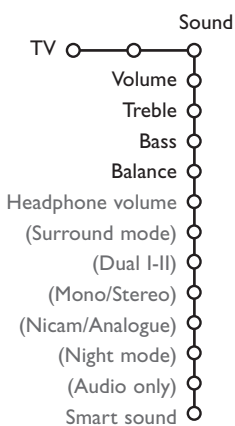

Sound menu

Select the menu items in the Sound menu with the cursor up/down and adjust the settings with the cursor left/right. Remember, control settings are at normal mid-range levels when the bar scale is centered.

Note: In case of a Cinema Link configuration and the Cinema Link is activated, the menu functions Surround mode, Night mode and Audio only of the Sound menu are steered by the audio receiver instead of by the receiver box. See the separate Cinema Link booklet supplied.

Volume

This control allows you to adjust the volume level.

Treble

Treble attenuates or amplifies the high-frequency response of the audio output signal.

Bass

Bass attenuates or amplifies the low-frequency response of the audio output signal.

Balance

This control allows you to adjust the balance of the right and left speaker's sound output.

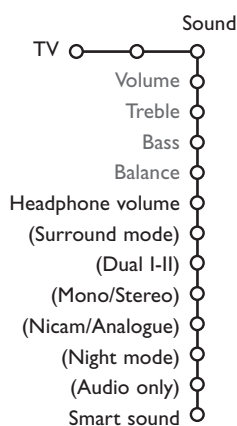

Headphone volume

This control allows you to adjust the volume level of the headphone.

Surround mode

Only selectable with a Cinema Link configuration. See separate booklet supplied.
 Dependent on the Cinema Link configuration and the sound signal broadcasted, select one of the Surround modes.

Dual I-II *(Only available with dual sound transmission)*

This control allows you to switch from **Language I** or **Language II** during dual sound transmission.
 Your selection is stored per TV channel.

Mono/Stereo *(Only selectable in case of analogue stereo transmission)*

Select **Mono** or **Stereo** with the cursor left/right.
 When **Stereo** has been selected, the television will reproduce any stereo broadcast signal it receives.
 If Stereo is not present on a selected programme and the TV is placed in Stereo mode, the sound coming from the set will remain monaural.
 Your selection is stored per TV channel.

Nicam/Analogue *(Only selectable in case of Nicam transmission)*

Select **Nicam** or **Analogue** if the TV channel transmits digital sound.
 In case of weak digital sound signals, due to the transmission, select Analogue.
 Your selection is stored per TV channel.

Night mode

Only selectable with a Cinema Link configuration. See separate booklet supplied.

Audio only

Only selectable with a Cinema Link configuration. See separate booklet supplied.

Smart sound

This menu item performs the same as the Smart sound  key on the remote control. See Use of the remote control, p. 12.
 Smart settings will be set to **Personal** if the following settings are changed manually: treble and bass.

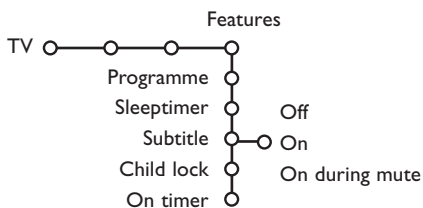

Features menu

Select the menu items in the Features menu with the cursor up/down and adjust the settings with the cursor left/right.

Programme list

This list will display all the stored TV channels. Select a programme number with the cursor up/down. Press the **OK** key to switch over to the selected TV channel or external.

Sleptimer

With the sleptimer you can set a time period after which the TV should switch itself to standby. The counter runs from **0 min.** up to **180 min.** One minute before the TV is set to go to standby, the remaining seconds and a message appears on screen. You can always switch off your set earlier or change the set time.

Note: When a VGA source is selected, the TV will not go to standby when the sleptimer expires.

Select subtitles

TV channels with teletext often transmit programmes with subtitling. For each TV channel you can store a subtitle page which will be displayed continuously if the programme being broadcast is transmitted with subtitles.

Switch on teletext and select the proper subtitle page from the index. Switch off teletext.

Now the subtitle page is stored for the selected TV channel.

Once subtitles have been stored and **Subtitle On** has been selected they will automatically be displayed on the selected TV channels if subtitles are in the transmission.

A symbol will indicate that the mode is on.

Select **On during mute** when you want to have the subtitles automatically been displayed when the sound has been temporarily interrupted with the **M** key on the remote control.

Child lock

The Child lock feature allows you to lock TV channels and externals to prevent children from watching certain programmes. A VGA source can not be locked.

- 1 Select **Child lock** with the cursor down.
- 2 Press the cursor right to enter the Child lock menu. You're summoned to enter your code. Enter the access code.
Note: You have to re-enter your code each time you've left the child lock menu.

Important: You have forgotten your code !

- Select **Cancel** with the cursor down.
- Select **Set/Change code** in the Setup menu. See General menu, Set/Change code, p. 8.
- 3 Select one of the menu items of the child lock menu.
 - Select **Lock** if you want to lock all channels and externals.
 - Select **Custom lock** and press the cursor right.
 - Select **Programme lock** if you want to lock the programmes from a certain TV channel or external.
 - Select **Lock after** if you want to lock all programmes from a certain time onwards. Press the cursor right and enter the time with the cursor up/down and right. Press the **OK** key to validate.
*Note: The entered time will remain valid for every day, until you have selected **Unlock**.*
 - Select **Unlock** to unlock all locked channels and externals at once.

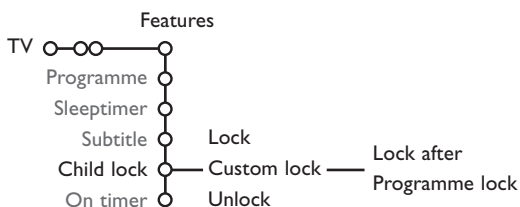

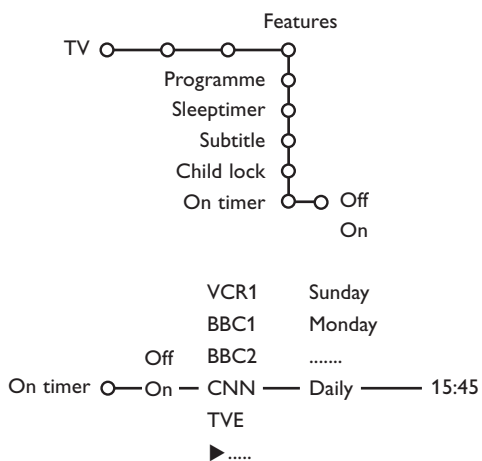



On timer

With the On timer function you can make your TV automatically switch to a specific programme number from standby or switch over to a different programme number at a specific time.

Note: Your TV receiver box and your monitor should not be powered off with the  power key.

- 1 Select **On timer** with the cursor down.
- 2 Select **On** with the cursor right.
- 3 Press the cursor right again to enter the channel list.
- 4 Select the TV channel or external you want your TV to switch to on a selected time and day. Not possible with a VGA source.
- 5 Press the cursor right again to select a day of the week or to select **Daily**.
- 6 Press the cursor right once again to enter the time.
- 7 Enter the time with the digit keys or with the cursor up/down.
- 8 Press the **OK** key to activate.
- 9 Press the **MENU**  key to turn off the menu.

Note: To check your timer settings, press the  key.

Dual screen/PIP (FTR 9964 only)



Press the **12** key to turn on or off Dual screen or PIP, according to the format selection made in the Dual screen format list in the General menu. See Setup, General, p. 7.

Audio from the main screen (the left screen in Dual screen and the full size screen in PIP) plays to the speakers;
Audio from the right screen or from the PIP plays to the headphones.

*Note: Continuing to hold the **12** key down will cycle the TV through the various formats (Dual screen, Large PIP, Medium PIP, Small PIP), launching a new format after each second the key is held down.*

To highlight a screen

Pressing the cursor left/right will toggle the highlight between the left and the right screen or between the main and the PIP screen.
The highlighted screen is made visible with a yellow border.

Changing TV channels or external sources in left, right or PIP screen

Press the **- P +** key, the digit keys or the PIP key in order to change the TV channels or the external sources in the highlighted screen.

Making the PIP screen movable

- 1 Select a PIP format.
- 2 Highlight the PIP picture with the cursor left/right.
- 3 Press the **OK** key to make the PIP screen movable. The PIP screen can now be moved. This is made visible with a blue border around the PIP screen.
- 4 Press the cursor up/down, left/right to move the PIP screen in the direction of the cursor press.
- 5 Press the **OK** key again. The PIP screen position is fixed.

Swapping screens

Press the **↔** key to swap the left and the right screen or the PIP screen. See notes below.

On-Screen information

The On-Screen information, which appears when changing channels, always refers to the highlighted screen.

Deactivating Dual screen mode

Press the **12** key again to return to a full main screen picture. The TV tunes to the picture which was highlighted in Dual screen mode.

Notes:

When Dual screen mode is selected, two picture formats are supported: Full screen or 4:3 letterbox picture format.

Multipip (FTR 9964 only)

In the Setup menu, General, p. 8 you selected which Multipip format you prefer to see.

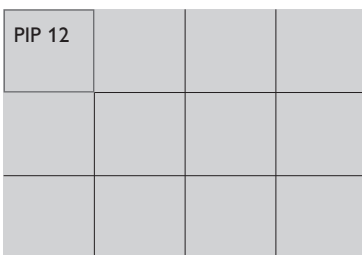
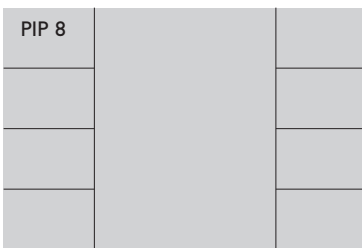
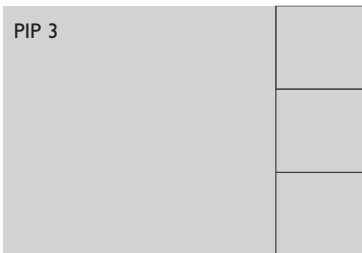

- 1 Press the  key on the remote control to toggle the selected Multipip format **On** or **Off**.

The main screen displays the channel or source tuned before Multipip was activated and the highlight is on the main screen.

- 2 Press the cursor left/right, up/down to highlight a PIP screen. When the highlight is on one of the PIP screens, it begins playing video and the other PIPs freeze. The main screen always continues playing audio and video.
- 3 Pressing the **- P +** or the **PiP** key or the digit keys changes the channel or source for the currently highlighted screen.

Note: channels cannot be added or deleted from the Smart surf list when Multipip is activated.

- 4 Press the  key to swap the highlighted screen and the main screen.
- 5 With PIP 3 and PIP 8: press the cursor up/down to display a following series of PIP screen.

With PIP 12: highlight the PIP picture in the bottom right and press the cursor down to display a following series of PIP screen.

*Note: Only TV channels which are in the favourite list and pictures from the connected and activated externals are displayed in the PIP screen.
PIP3 and PIP8 are not possible when a VGA source is displayed as main screen.*

Teletext Guide

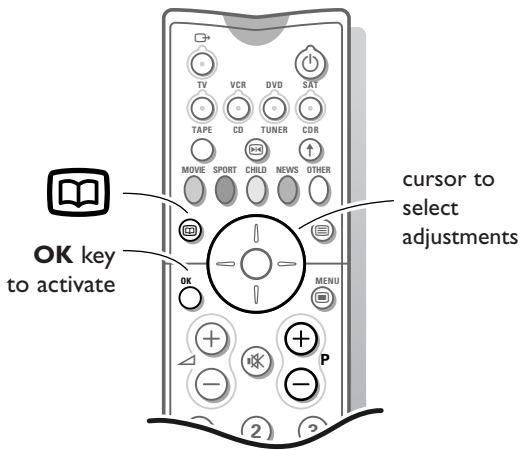

TV channels which broadcast teletext also transmit a page with the programme guide of the day.

If the displayed teletext programme guide page satisfies the Video Programming via Teletext (VPT) requirements, it will be possible to record, remind, watch or lock programmes.

- 1 Press the  key.
- 2 Select a TV channel with the cursor up/down and press **OK**.
- 3 Move the cursor up to the top of the channel list where the name of the selected TV channel reappears.
- 4 Press the cursor right to move the puck over the selection ball.
- 5 In the teletext index page, look for the programme guide page of the day or the following day.
- 6 Enter with the digit keys, the programme guide page number. Press the cursor right twice to move the puck to the right to choose one of the subpages if available.

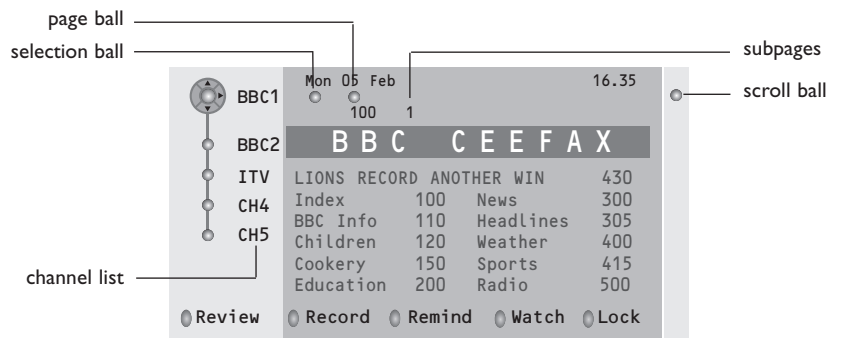

If the selected programme satisfies the VPT requirements, the TV will remember the last selected teletext page number of that channel that contains programme guide information and indicates which programme starts at what time.

Every time you press the  key, the teletext programme guide page of the selected TV channel will be available.

Note: The broadcaster is responsible for the content of the information.

Basic functions

Press one of the grey, red, green, yellow or blue keys to activate a Teletext Guide function. The keys appear in grey if the function is not available.

Review: this menu provides a list of programmes that are marked as reminders, those that have to be recorded and those that are locked. This menu can be used to change or remove marked programmes.

Record: to programme the recording of the video recorder (if it has a NEXTVIEWLink function and is connected to **EXT. 2**).

Remind: to automatically switch on the TV if it is in standby or to display a message if the TV is on.

Lock: to lock certain programmes to prevent recording or watching. For the functions Record, Remind or Lock, a small menu pops up in which you can choose the interval: once, daily or weekly, or clear an earlier made record, remind or lock setting. The default interval is set to Once. To confirm the frequency, press the **OK** key.

Watch: to watch the selected and currently broadcast programme.

Teletext

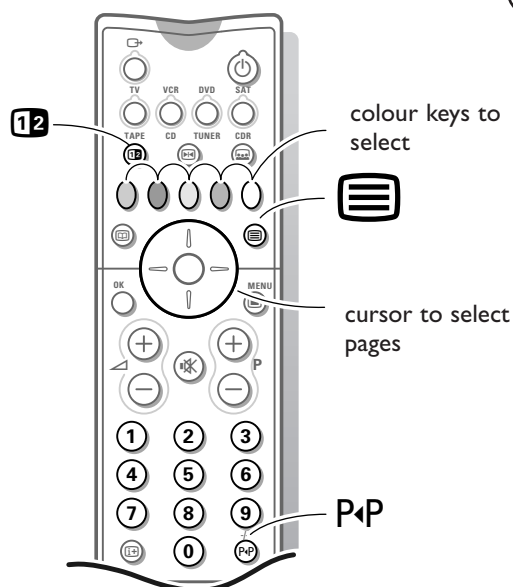

Most TV channels broadcast information via teletext.

Depending on the TV channel, teletext is transmitted in different systems. The colours used in the bottom line of the teletext page correspond with the colour keys of your remote control.

Switch Teletext on and off

Press to switch the teletext on or off.

The main index page appears on the screen together with an information line at the top, an option line at the bottom and a puck in the top left corner of the screen.

Select a Teletext page

With the digit keys

Enter the desired page number with the digit keys.

The page counter seeks the page or the page appears immediately when the page number has been stored in the memory.

A message appears when you have entered a non-existent or incorrect page number. Page numbers beginning with 0 or 9 do not exist. Choose another number.

With the option line

Select with the colour keys, corresponding to the coloured options at the bottom of the screen, the desired subject.

Select Picture/Teletext

Select a TV channel which broadcasts teletext.

Press to switch the teletext on.

Press the **12** key.

The screen is divided into two parts:

the left side for the normal main picture,

the right side for teletext broadcast by the selected TV channel.

Press the key to return to a full screen picture or press the **12** key to return to a full teletext picture.

Quickly run through the teletext pages

Press the cursor up/down or the - P + key to run through the previous or the following pages.

Select the previously selected teletext page

Press the P+P key.

Note: Only possible when teletext pages are active, not when the Teletext menu is displayed.

Select the index teletext page

Press the grey colour key to display the main index (usually p.100).

Only for T.O.P teletext broadcasts :

T.O.P orders the pages in categories and adds other possibilities of enhancing ease of use.

Press . A T.O.P overview of the teletext subjects available is displayed.

Not all TV channels broadcast T.O.P. teletext. When the teletext system

is not T.O.P. teletext, a message appears at the bottom of the screen.

Select with the cursor up/down, left/right the desired subject and press the **OK** key.

puck

Mon 05 Feb 16.35.22

BBC CEEFAX

LIONS RECORD ANOTHER WIN 430			
Index	100	News	300
BBC Info	110	Headlines	305
Children	120	Weather	400
Cookery	150	Sports	415
Education	200	Radio	500
Lottery	230	Travel	550
Finance	240	Subtitling	888
Music	280	TV Listings	600
Red	Green	Yellow	Blue

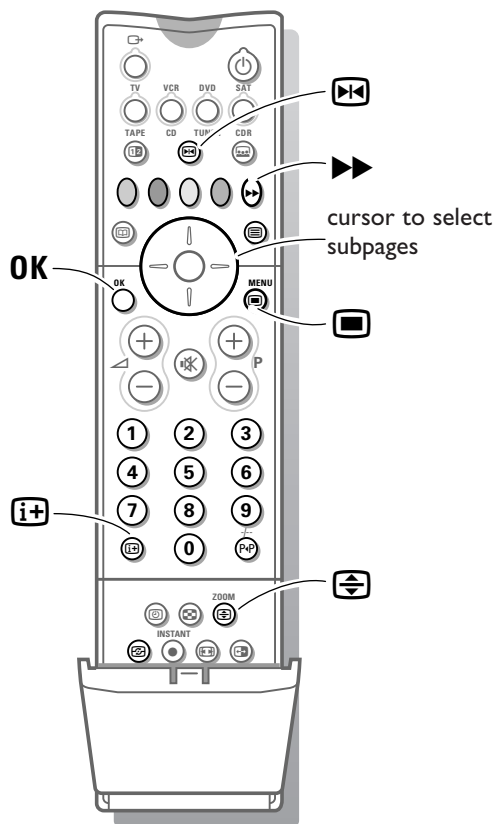

Select subpages

When a selected teletext page consists of different subpages, one of the subpages appears on the screen.

Press the cursor right to highlight the subpagenumber.

Press the cursor up/down to select the next or previous subpage or enter the subpagenumber with the digit keys.

Teletext menu (only available in full screen teletext mode)

- 1 Press the **MENU** key to activate the menu.
- 2 Press the cursor up/down to select the menu items.

Favourite

This list contains up to eight favourite teletext pages.

Only the pages of the current channel can be selected.

- 1 Press the cursor right to add the current page or to select one of the favourite pages to the list.
- 2 Press the **OK** key or the cursor right again to add.
- 3 Press the cursor left to return to the Teletext menu.

Search

On the virtual keyboard on screen you can type in a word you want to search for in the teletext pages. Whether upper- or lowercase is used has no influence. Searching for numbers is not possible.

- 1 Press the cursor left/right, up/down to select the characters, words or functions.
- 2 Press the **OK** key to confirm each character selected.
- 3 Select **Cancel** to cancel the word or character selected. Select **Space** to enter a space; **Delete** to delete the last character selected; **Shift** to switch between undercast or capital characters; **Special** to display special characters on the keyboard.
- 4 Press the cursor left repeatedly to return to the Teletext menu again.

Searching a word

- 1 Type in the word on screen or select a word from the history list on the right. Whether upper- or lowercase is used has no influence. Searching for numbers is not possible.
- 2 Select **Search** and press **OK** again. The message **Searching** appears. When the word is found, it is highlighted in the teletext page.
- 3 To continue the search, press the **OK** key twice. When a word is not found, a message appears.
- 4 To search for a new word, select **Keyboard** and press **OK**.
- 5 Select the new word.

Reveal

Reveals/conceals hidden information on a page, such as solutions to riddles and puzzles. Press the **OK** key to activate.

Press **OK** again to return to the **Teletext** menu.

Cycle subpages

Makes the subpages cycle automatically. Press the **OK** key to activate.

Timed page

To display a specific page at a certain time.

- 1 Press the cursor right to select **Yes** or **No**.
- 2 Enter the time and pagenumber with the cursor keys or the digit keys.
Note: Teletext does not have to remain switched on. It is not possible to display a timed page when in VGA mode or when the TV is switched to standby.

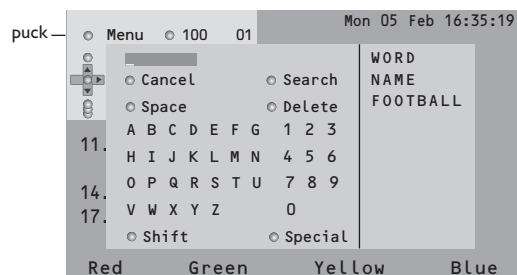

puck →

Menu	100 1	Mon 05 Feb	16.35.22
Reveal		C E E F A X	
Cycle subpages	ER WIN	430	
Timed page	0	News	300
Language	0	Headlines	305
	0	Weather	400
	0	Sports	415
Education	200	Radio	500
Lottery	230	Travel	550
Finance	240	Subtitling	888
Music	280	TV Listings	600
Red	Green	Yellow	Blue

Language

If the displayed characters on screen do not correspond with the characters used by the teletext broadcaster, you can change the language group here.

Select **Group 1** or **Group 2** with the cursor keys left/right.

To leave the Teletext menu

- 1 Press the  **MENU** key.
- 2 Press the cursor right.
- 3 Press the cursor left twice to put the puck on the neutral spot again.

Special teletext functions

Hold

Press  to stop the automatically rotating of the subpages or to stop the page counter from seeking when you have entered a wrong page number or when the page is not available. Enter another page number.

Enlarge

Press  repeatedly to display the upper part, the lower part and then to return to the normal page size. When the upper part is displayed, you can scroll the text, line by line using the cursor up/down.

Hypertext

With hypertext you can select and search for any word or number on the current teletext page.

- 1 Make sure you are not in the teletext menu and that the puck is in the upper left corner of the screen.
- 2 Press the cursor key down to highlight the first word or a number on the page.
- 3 Use the cursor up/down, left/right to select the word or number you want to search for.
- 4 Press the **OK** key to confirm.
A message appears at the bottom of the screen to indicate that the searching is going on or that the word or page is not found.
- 5 Press the cursor right to leave hypertext.

Select Continuous Subtitles

TV channels with teletext often transmit programmes with subtitling. For each TV channel you can store a subtitle page which will be displayed continuously if the programme being broadcast is transmitted with subtitles.

Switch on teletext and select the proper subtitle page from the index.

Switch off teletext.

Now the subtitle page is stored for the selected TV channel.

Once subtitles have been stored and **Subtitle On** has been selected they will automatically be displayed on the selected TV channel if subtitles are in the transmission.

Select **Subtitle On** or **Off** in the Features menu, see p. 16.

The subtitle symbol  appears when **Subtitle On** is selected.

Connect Peripheral Equipment

There is a wide range of audio and video equipment that can be connected to your receiver. The following connection diagrams show you how to connect them to the back or the front side of the receiver.

Note: in case of the monitor in a stand alone situation without the receiver box connected, see the instructions with the monitor.



Philips Cinema Combination

If you dispose of a Home Cinema combination (Cinema Link audio receiver and/or Cinema Link video recorder and/or DVD player), see the separate supplied instruction manual.

Video recorder

Note: Do not place your video recorder too close to the screen as some video recorders may be susceptible for signals out of the display. Keep a minimum distance of 0.5 m to the screen.



Connect the supplied aerial cables ①, ② and, to obtain a better picture quality, a eurocable ③ as shown opposite.



If your video recorder is provided with the EasyLink function, the eurocable supplied with it, should be connected to EXTERNAL 2 to benefit of the EasyLink function.

Only if you do not connect the eurocable ③, you have to do the following:

Search for and store the test signal of the video recorder

- ① Unplug the aerial cable ① from the aerial socket  of your video recorder.
- ② Switch on your TV and put the video recorder on the test signal. (See the handbook for your video recorder.)
- ③ Search for the test signal of your video recorder in the same way as you searched for and stored the TV signals. See Installation, Searching for and storing TV channels, Manual Installation, p. 6.
- ④ Store the test signal under programme number 0 or between 90 and 99.
- ⑤ Replace the aerial cable in the aerial socket  of your video recorder after you have stored the test signal.

Decoder and video recorder

Connect a eurocable ④ to your decoder and to the special euroconnector of your video recorder. See also the video recorder handbook. See Decoder, p. 9.

You can also connect your decoder directly to **EXTERNAL 1** or **2** with a eurocable.

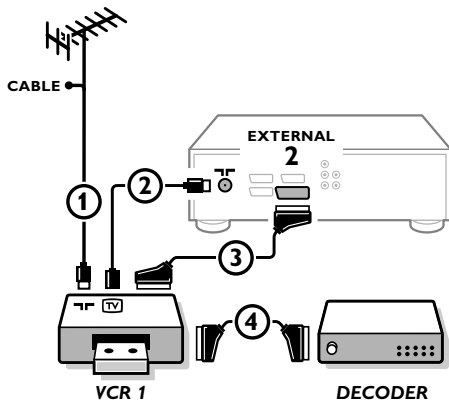

Video recorder and other peripherals

- 1 Connect the aerial cables ①, ② and ③ as shown opposite. Better picture quality can be obtained if you also connect eurocable ⑤ to **EXTERNAL 2** and a eurocable ④ to **EXTERNAL 1, 3 or 4**.
- 2 Look for the test signal of your peripheral in the same way as you do for a video recorder.

When a video recorder is connected to **EXTERNAL 1** you can only record a programme from your TV tuner.
Only when a video recorder is connected to **EXTERNAL 2** it is possible to record a programme from your TV as well as from other connected equipment. See Record with your video recorder, p. 30.

Note: **EXTERNAL 1** can handle CVBS and RGB, **EXTERNAL 2** CVBS, Y/C and RGB, **EXTERNAL 3 and 4** only CVBS, **EXTERNAL 5** YUV.

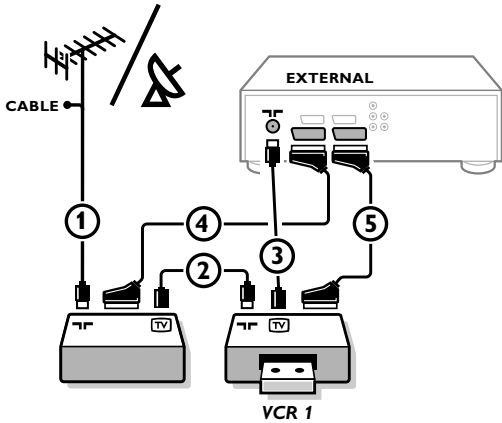

Camera & camcorder

- 1 Connect your camera or camcorder to the **FRONT** input behind the door at the front side of your receiver. Press the centre of the door to open.
- 2 Connect the equipment to **VIDEO IN** ② and **AUDIO L** ① for mono equipment.
- 3 For stereo equipment also connect **AUDIO R** ①.

S-VHS quality with an S-VHS, Hi-8 or Digital camcorder is obtained by connecting the S-VHS cables with the **S-VHS** input ③ (instead of **VIDEO IN** ②) and **AUDIO** inputs ①.

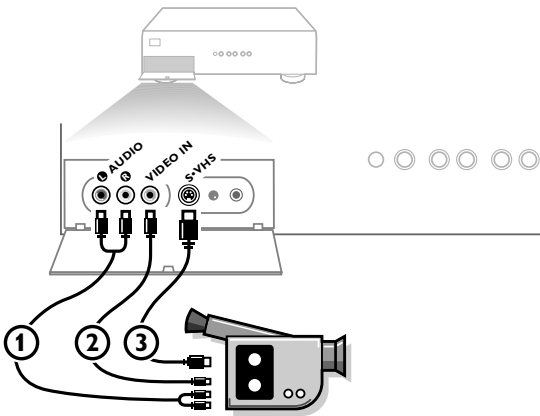

DVD Player

With euroconnector

Connect your DVD player with a eurocable to one of the euroconnectors **EXTERNAL 1** or **2**.

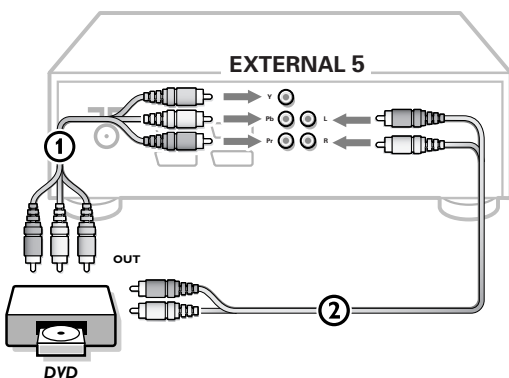

With Component Video Output Connectors (**EXTERNAL 5**)

- 1 Connect the three separate component video cables to the DVD player's **Y, U (Pb)** and **V (Pr)** jacks and to the **Y, Pb** and **Pr** jacks on the receiver.
- 2 Connect the audio cable to the DVD player's audio **L** and **R** jacks and to the **L** and **R** audio **EXTERNAL 5** jacks on the receiver.

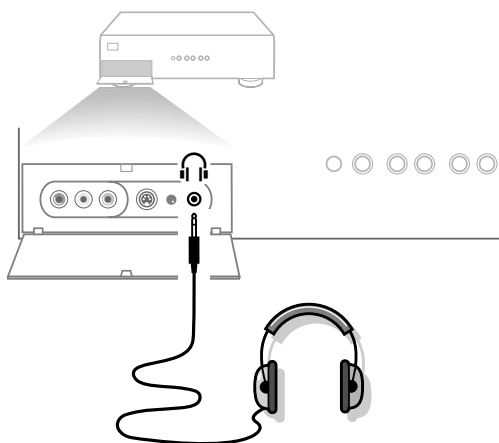

Headphone



- 1 Insert the plug into the headphone socket  behind the door at the front side of the receiver. Press the centre of the door to open.
- 2 Press  to switch off the internal loudspeakers of the TV.
*The headphone impedance must be between 8 and 2000 Ohm.
The headphone socket has a 3.5 mm jack.*

In the **SOUND** menu select **Headphone volume** to adjust the headphone volume and balance and to select the audio source for your headphone sound. See p. 15.

Note: When a TV channel or external source is blocked via the Childlock menu (see p. 16), also the headphone is muted.

When Dual screen PIP is activated (see p. 18) (FTR 9964 only) :
- if the main screen displays a TV channel picture, you hear the sound from the Dual screen/PIP picture through your headphone;
- if the main screen displays a picture from an external source, you hear the sound from the main screen through your headphone.

Multi channel Surround receiver

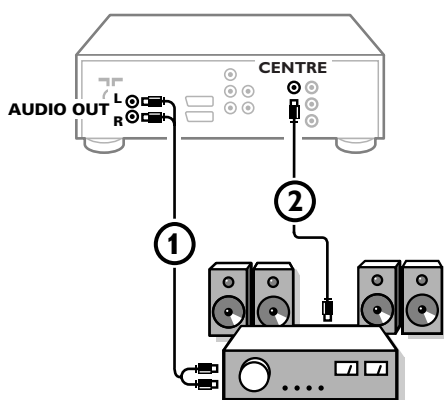

- 1 Connect the audio cable to the multi channel Surround receiver and to **AUDIO OUT L** and **R** at the back of your TV receiver box ①.
- 2 If you want the loudspeakers of your monitor to act as centre speaker, also connect an audiocable to the multi channel Surround receiver and to the **SURROUND SOUND CENTRE IN** at the back of your TV receiver box ②.
- 3 Select **Centre mode On** in the Setup, General menu. See p. 9.

The loudspeakers of the monitor will now only produce centre sound, the loudspeakers connected to the audio receiver will produce Surround Sound. The volume has to be controlled via the multi channel Surround receiver.

Note: No sound will be heard when a TV channel or external source is blocked via the Child lock menu (see p. 16).

Connect your computer

See the separate supplied instruction manual with your monitor.

To select connected equipment

Equipment connected with an aerial cable only :

Select the programme number under which you have stored the test signal with the digit keys.

Equipment connected to a euroconnector, to the VGA MONITOR IN connector or to the front side of the receiver box

Press the  key repeatedly to select **EXT1, EXT2, EXT3, EXT4, EXT5, FRONT** or **VGA**, according to where you connected your equipment at the back or the front side of your receiver.

Press the **OK** key to confirm.

Remark : Most equipment (decoder, video recorder) carries out the switching itself. This is however never the case with a computer connected to the VGA input.

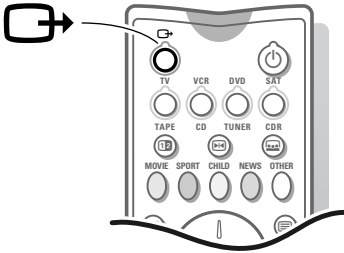

If you want to change to TV channels?

Enter the programme number of the TV channel which you want to watch with the digit keys.



VGA menu

Only available when a VGA source has been connected and activated. See also the separate supplied instruction manual with your monitor.





- 1 Select **VGA** with the  key and press the **OK** key to confirm.
- 2 Press the **MENU**  key to switch on the **VGA** menu.









- 3 Select one of the menus with the cursor left/right.
- 4 Select one of the menu items with the cursor up/down.

See the separate booklet supplied with the monitor.





Picture 1

-  Brightness,
-  Contrast,
-  Colour temperature,
-  Sharpness,





Picture 2

-  Format,
-  Zoom,
-  Zoom factor,
-  Shift,
-  Clock frequency,
-  Phase,
-  Auto align

Sound

-  Volume,)
-  Bass,)
-  Treble,)
-  Sound mode)

Setup

-  Language,
-  Power savings,)
-  AV3,)
-  VGA2)

- 5 Press the cursor left/right to alter the selected adjustment.
- 6 Press the **MENU**  key again to switch off the **VGA** menu.

Video recorder with EasyLink

The video recorder can be operated via the VCR menu on screen.

- 1 Press the **MENU**  key on the remote control.
- 2 Select the **VCR** menu with the cursor up/down.

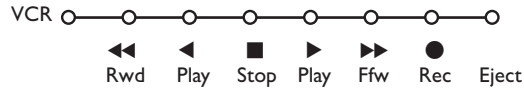

- 3 Press the cursor left/right, up/down to select one of the VCR functions:

- Rwd rewind,
- Play play back: scan at **Slow, Min, Med, Max** speed
- Stop stop,
- Play play forward: scan at **Slow, Min, Med, Max** speed,
- Ffw fast forward,
- Rec record,
- Eject select and press the **OK** key to eject the tape.

The key **INSTANT**  for recording, under the door of the remote control, can be operated in the TV mode.

If your EasyLink video recorder has the system standby function, when you press the  key for 3 seconds, both TV and the video recorder are switched to standby.

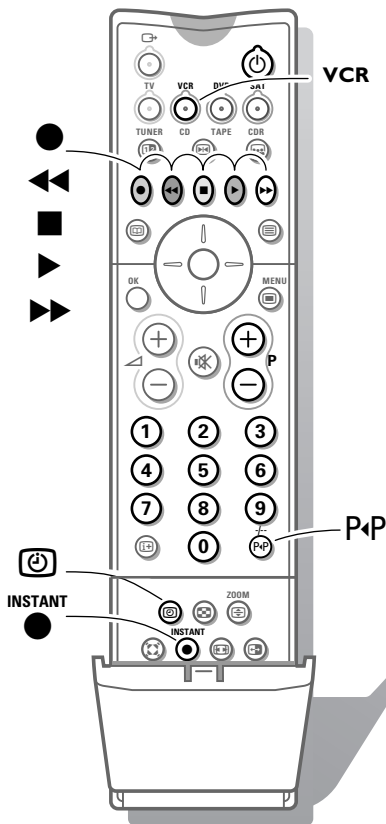











Audio and video equipment keys

Most of the audio and video equipment from our range of products can be operated with the remote control of your TV.

Press the **VCR, DVD, SAT, TUNER, CD, TAPE** or **CDR** key according to the equipment you want to operate with this remote control. See Use of the remote control, p. 10.

Video recorder without EasyLink

Press one of the video recorder keys after you pressed the **VCR** key:

-  for record,
-  for rewind,
-  for stop,
-  for play,
-  for fast forward,
-  for selecting 1- or 2-digit programme numbers from the video recorder,
-  - P + for sequential programme selection from the video recorder tuner,
-  0 to 9 to select a programme number from your video recorder tuner,
-  to switch the video recorder to standby
-  VCR timer

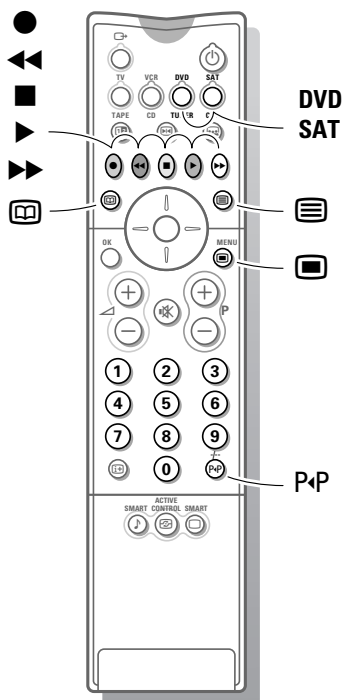

DVD keys

Press one of the following keys after you have pressed the **DVD** key.

- to switch the DVD menu on or off
- DVD** to select a DVD chapter
- to select a DVD title
- to select your choice of subtitle language
- for search backward
- for stop
- for play
- for search forward
- for pause
- 0-9 to select a programme number from your DVD

Satellite receiver

Press one of the TV keys after you have pressed the **SAT** key.

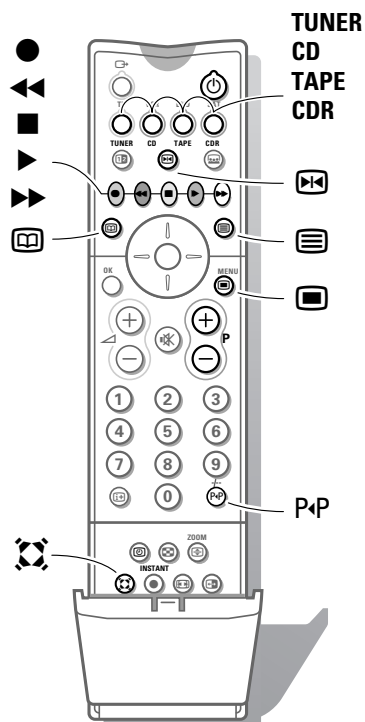

Tuner, CD, Tape and CDR keys

Press one of the following keys after you have pressed the **TUNER, CD, TAPE** or **CDR** key.

- to switch the menu on or off (tuner)
- P+P** to select a frequency (tuner)
- to record
- to search down (tuner); rewind (CD/tape); speed down (CDR)
- stop
- play
- to search up (tuner); forward (CD/tape); speed up (CDR)
- RDS news/TA (tuner); select following disc (CD/CDR)
- pause (CD/CDR/tape)
- RDS display (tuner); info on screen (CD/CDR)
- P +** next/previous (CD)
- surround modes (CD/CDR/tape)

Record with your video recorder without EasyLink

To record S-VHS quality, connect an S-VHS peripheral directly to the video recorder.

Record a TV programme

- 1 Select the programme number on your video recorder.
- 2 Set your video recorder to record.
See the handbook for your video recorder.

Switching programme numbers on your TV does not disturb recording !

Record a programme on your video recorder connected to EXTERNAL 2 from Audio/Video equipment connected to EXTERNAL 1, EXTERNAL 3, EXTERNAL 4, EXTERNAL 5 or to sockets on the receiver

- 1 Switch on the equipment.
- 2 Select the correct external on your video recorder.
- 3 Set your video recorder to record.
You record what you are watching on the screen.

Do not switch programme numbers or do not switch off your TV when you are recording !

Record with your video recorder with EasyLink

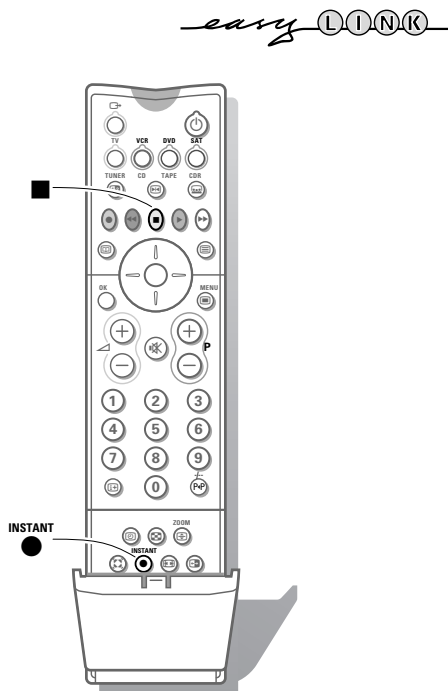

If you have connected an S-VHS video recorder provided with the EasyLink function, you can record S-VHS quality from an S-VHS peripheral connected to the front side of the receiver. (E.g. from an S-VHS camcorder.)

In TV mode, it is possible to start a direct recording of the programme which is being displayed on the TV screen.

- 1 Press the **INSTANT** ● record key, under the door of the remote control of the TV or of the video recorder or the record key on the video recorder.
The video recorder switches on from standby and a message of what is being recorded appears on the screen.
The video recorder starts recording the programme you are watching.
- 2 Press the ■ key to stop the recording.

Do not switch programme numbers or do not switch off your receiver when you are recording !

When recording a programme from a peripheral connected to EXTERNAL 1, 3, 4, 5 or FRONT, you can not select another TV programme on the screen.

To watch TV programmes again, press the programme number you want to select twice.

Attention: the recording is stopped and your video recorder switches to standby.

If you switch to standby during recording of a programme from a peripheral connected to EXTERNAL 1, 3, 4, 5 or FRONT, the blinking lamp on the front of your receiver indicates that you are still recording. The blinking stops after the recording is finished.

Attention:

Recording from EXTERNAL 5 will only have black and white pictures.

Tips

Poor Picture

- Have you selected the correct TV system?
- Is your monitor or house aerial located too close to loudspeakers, non-earthed audio equipment or neon lights, etc.?
- Mountains or high buildings can cause double pictures or ghost images. Sometimes you can improve the picture quality by changing the direction of the aerial.
- Check if you have entered the correct frequency. See Installation, p. 6.
- Are brightness and contrast out of adjustment? Select Factory settings in the Setup, General menu, p. 8 or press the **SMART** key repeatedly.

No picture or no sound

- Are the supplied cables connected properly? (The aerial cable to the TV receiver box, the other aerial to your VCR, the VGA cables to the display, the power cables.)
- Has the childlock (p. 16) been switched off?
- Is your PC switched on?
- Has the Centre mode been switched off?
- Do you see a black screen and the indicator in front of the monitor lights up green, this means that the display mode is not supported. Switch your VGA-source to a correct mode.
- In case of weak or bad signal, consult your dealer.

Remote control

- If your monitor no longer responds to the remote control, the batteries may be exhausted.
- You can still use the **MENU** keys at the front of your receiver.

Menu

Have you selected the wrong menu? Press the same key again to exit from the menu.

Control of peripheral equipment

The infrared signals of the screen may influence the reception sensibility of other peripherals.

Solution: replace the batteries of the remote control or change position of other equipment. E.g. keep away a wireless headphone from within a radius of 1.5 m.

TV-Guide - Displayed time is wrong

The broadcaster on programme number one does not transmit the correct local date and time. Use **Reshuffle** in the **INSTALLATION** menu to place another broadcaster on programme number one.

No stable or not synchronised VGA picture

Check if you have selected the correct VGA mode in your PC. See the separate instruction manual with the monitor.

If your problem is not solved:

Switch both your monitor and your receiver off and then on again.

Never attempt to repair a defective monitor or receiver yourself.

Check with your dealer or call a TV technician.

End of life directives

We are paying a lot of attention to using environmentally-friendly production methods. Your new flat colour television contains materials which can be recycled and reused.

At the end of life specialised companies can dismantle the discarded flat colour television to concentrate the reusable materials and to minimise the amount of materials to be disposed of.

Please ensure you dispose of your old flat colour television according to local regulations.

How to dispose of exhausted batteries?

The batteries supplied do not contain the heavy metals mercury and cadmium. Nevertheless in many countries exhausted batteries may not be disposed of with your household waste. Please ensure you dispose of exhausted batteries according to local regulations.

TV receiver box with speakerless monitor

In case you connect your TV receiver box with a speakerless monitor, and without having connected an audio receiver, all references made in this instruction book to sound reproduction, volume control, and audio connections, are not applicable (except for a headphone connection). The keys on the remote control referring to sound have no function either.

Miscellaneous

- . Ambient temperature: + 5~ + 40°C
- . Mains: 50/60 Hz Auto Voltage ranging from 95 V to 264 V
- . Power consumption: around 35 W
- . Standby consumption: 2 W
- . Weight (excl. packaging): 4 kg
- . Dimensions (wxhxd): Receiver: 43.5 x 10.5 x 33 cm

Index

- a active control, 12
- auto format, 11
- automatic installation, 6
- c camcorder, 25
- centre mode, 9
- child lock, 16
- code, 16
- connect your computer, 26
- continuous subtitles, 23
- country, 5
- d decoder, 9
- digital natural motion, 13
- DNR, 13
- dual screen/PIP, 18
- dual screen format, 7
- dvd keys, 29
- dynamic contrast, 13
- e eurocable, 24
- f factory settings, 8
- favourite tv channels, 6
- freeze format, 10
- frequency, 6
- g give name, 6
- h headphone, 26
- hypertext, 23
- i info on screen, 10
- interrupt the sound, 10
- l language, 5
- m manual installation, 6
- menu language, 5
- menu-system, 4
- multitip, 19
- o on timer, 17
- p peripheral equipment, 24
- picture adjustments, 13
- picture format, 11
- programme list, 16
- r recording, 30
- reshuffle, 6
- s set/change code, 8
- setup, 7
- sleeptimer, 16
- smart keys, 12
- smart surf, 11
- sound adjustments, 14
- source, 9
- stereo, 11
- store TV channels, 5
- subpages teletext, 22
- subtitles, 16
- S-VHS, 30
- surround mode, 11
- switch TV on, 3
- t teletext, 21
- teletext guide, 20
- time display, 11
- tint, 13
- v VGA menu, 27
- video recorder, 24
- volume, 10

Automatic Channel Installation (ACI)

Automatically installs all TV channels in the same order as offered by your cable company, provided of course that the data is transmitted. It also automatically includes programme number and programme name.

With ACI, channel installation is fully automatic, simple and fast.

Child Lock

Feature to prevent unauthorised use of your TV. The TV can only be switched on and operated with the remote control.

Cinema Link

Cinema Link is a new Philips feature in which the TV, the audio receiver and other video peripherals like DVD player and video recorder communicate with each other; on condition they are all equipped with the Cinema Link functionality and connected via a eurocable. They automatically offer the highest quality combination of picture and multi channel surround sound to create your own Home Cinema.

DNR

Dynamic Noise Reduction.

By encoding signals digitally in 100 Hz sets with Digital Scan it is possible to clean up picture noise. This is especially beneficial in poor signal areas and when viewing poor quality video tapes.

Easy Link

Digital 'intelligent' ESI bus-system between audio components in HiFi systems and between TV and VCR. (Scart connection required). Turns source selection and control into a one-key operation.

Easy Text

Teletext memory that automatically memorises Teletext pages and gives you instant access to them.

Euroconnector

A 21-pins connector system enabling you to simply connect various types of audio/video and computer equipment.

Menu

On-screen display of functions and facilities in a well-organised survey.

NTSC

The broadcasting system used in the USA, Japan and parts of South America and Southeast-Asia.

Picture Freeze

TV mode which allows you to "freeze" a certain image in order to study a specific detail at ease, e.g. to make notes of certain programme information like phone numbers.

Smart Picture and Sound Controls

Keys on the remote control to select predefined picture and sound settings.

Sleeptimer

Function with which you can set a time period after which the TV should switch itself to standby.

Teletext

See also Easy Text

WST: World Standard Teletext.

FLOF: Full Level one Features. System applied by the BBC, RVE.... that provides a fast access to the teletext pages.

TOP: Table of (Teletext) Pages. German system for an easy access to the teletext pages.

Wide screen format

Some external devices (e.g. VCR, DVD, SAT) can be configured with their local menus to output pictures in 16:9 picture format. In this case the wide screen picture format makes the picture fill the screen without distortion.

Cinematicink



Let's make things better.



PHILIPS

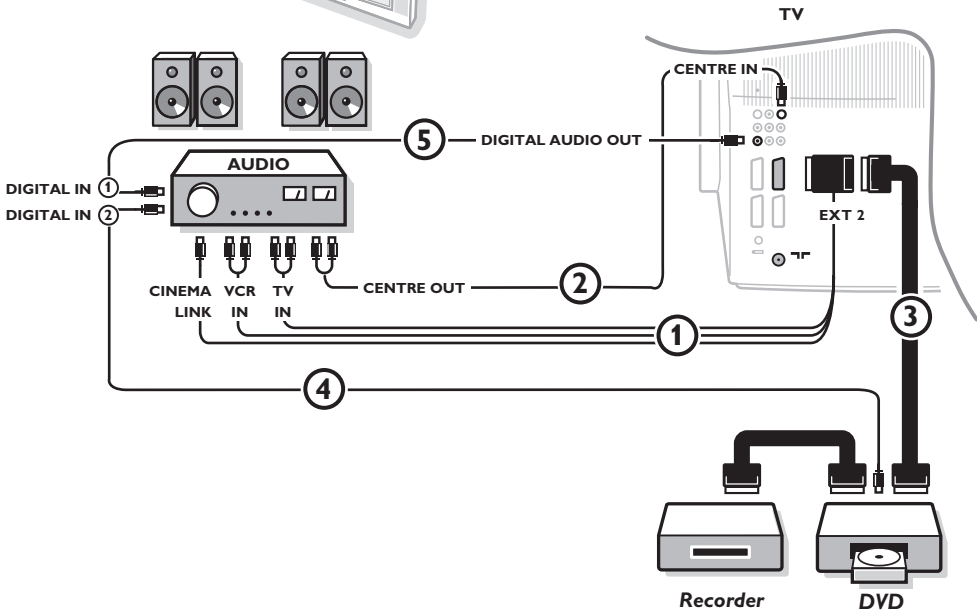
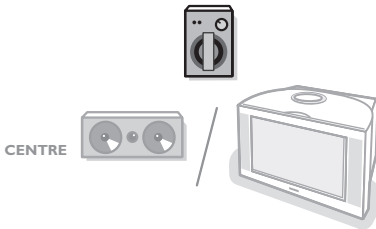
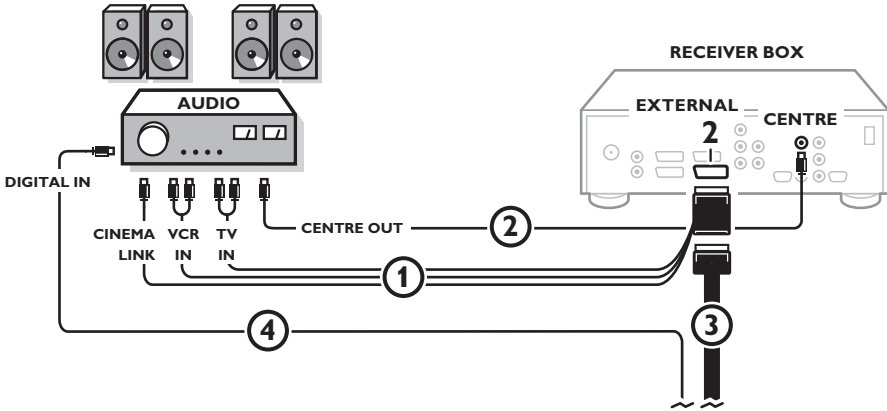
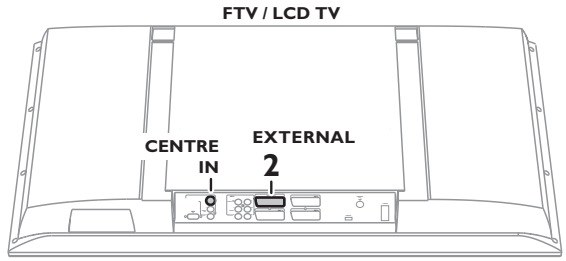
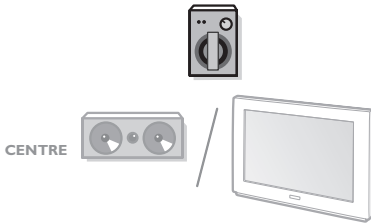



Note: The Cinema Link functionality is only available with devices of the Cinema Link (P50.3) generation !

Cinema Link is a new Philips feature in which the TV, the audio receiver and other video peripherals communicate with each other (on condition they all are equipped with the Cinema Link functionality and are connected via a eurocable). They automatically offer the highest quality combination of picture and multi channel surround sound to create your own Home Cinema.

With one key on the remote control, with which you can control all Cinema Link products, your total Cinema Link system will be started and the DVD or video recorder will start to play and the audio receiver will provide the sound (on the condition Cinema link is enabled) on behalf of the TV.

The TV or monitor can function as the centre speaker of your system, making a separate centre speaker unnecessary (only in case your TV or receiver box is equipped with a Centre IN connector).

By pressing the standby key  on the remote control for at least 3 seconds, the complete Cinema Link system will be switched to standby.

Recommended:

Do not use the AC outlet at the back of the audio receiver to power the DVD or the video recorder in a Home Cinema configuration.

Configuration of the Cinema Link peripherals

The connection diagram in the inside cover shows you how to connect the Cinema Link peripherals with each other.

Notes:

- Besides the TV or receiver box at least one peripheral should be provided with the Cinema Link functionality to benefit from this feature.
- To take advantage of the highest quality of multi channel Surround sound it is advisable that you have a Cinema Link audio receiver connected.
- The peripherals connected don't need to see the TV remote control in the Cinema Link system. The commands given to the TV are automatically passed to the other peripherals. This allows you to put the peripherals behind the doors of a cabinet or to place them in another room.
- To enjoy Digital Surround playback, the digital device (e.g. DVD) should be connected to the digital input of the audio receiver with a separate cinch audio cable **④**. In case your TV is provided with a DIGITAL AUDIO OUT connector, also connect it to one of the digital input connectors of your audio receiver **⑤**. If you connect the digital audio output connector of your TV and/or peripheral equipment to a digital input connector of your audio receiver **④** and **⑤** (if present), select the appropriate digital input (1 or 2) in your audio receiver.
- The optional wireless speakers of the TV cannot be used.

Preparation and Operation

- 1** Cinema Link is switched on as soon as the audio receiver and the TV are switched on. If necessary, Cinema Link may be switched off or on again only on the audio receiver. See the instructions for use of your audio receiver.
Important: When Cinema Link is switched on all audio commands control the audio receiver instead of the TV.
- 2** The message **CINEMALINK ON** is displayed on the audio receiver and on the TV. Now the CinemaLink system is activated.
Note: it is recommended to disable CinemaLink when the receiver is used to record a CD e.g. or when using a headphone when others are watching TV.

Now you can adjust the initial TV settings for optimal surround sound and install the audio channels before starting up one of the CinemaLink devices. The system information about country choice, menu language and picture format you set up during the installation of the TV is transferred to the audio receiver automatically.

TV as centre speaker (only in case your TV or receiver box is equipped with a Centre IN connector)

See the Instructions for Use of the TV or receiver box, Setup, Source menu, Centre input. Use the test tone function in the Speakers menu to have a reference of the loudness of the separate speakers.

*Note: If you want the loudspeakers of your TV or monitor to act as centre speaker, also connect a cinch audio cable (not supplied) **②** to the CENTRE IN connector of your TV or receiver box.*

Activating CinemaLink

Continue to press the -key on the remote control for more than 4 seconds.

- 1 The TV or receiver box sends a play command to the Cinema Link DVD player, if present.
- 2 The DVD player will start playing and the audio receiver automatically switches to the best Cinema Link sound.
- 3 If no DVD player is connected or if the DVD player has no disc loaded, the command can not be executed.
- 4 The TV or receiver box will then send a play command to the Cinema Link video recorder, if present.
- 5 The video recorder will start playing and the audio receiver selects the best Cinema Link sound.
- 6 If no video recorder source is connected or tape is loaded, the TV or receiver box will select the last watched TV channel.

Receiver menu

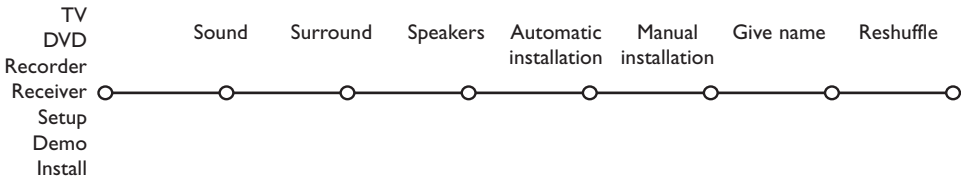

Note: When Cinema Link is enabled, certain items of the Sound menu (see TV menu) are steered by the audio receiver instead of by the TV or receiver box.

- 1 Press the **MENU** key on the remote control.
- 2 Press the cursor down to select **Receiver**.
- 3 Press the cursor right to enter the Receiver menu items.
- 4 Press the cursor up/down to select the submenu items.

Note: the audio receiver submenu items may only be selected if provided by the audio receiver (dependent on the configuration setup and the sound signals transmitted).

Sound menu

Dependent on the audio receiver speakers configuration, you may not be able to select certain menu items.

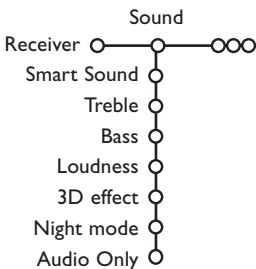

Smart Sound, Treble, Bass

See the Instructions for Use for the TV or receiver box.

Loudness

When **Loudness On** is selected and when listening at low volume, the low and high frequencies are amplified so that the natural balance is restored.

3D effect

3D effect enables you to experience the effect of Dolby Surround Pro Logic without the need of having rear speakers connected or activated.

Select the level of 3D effect with the cursor left/right.

Night mode *(only functional with Dolby Digital sound broadcasting input)*

The loud parts of the sound are lowered and the soft passages are raised.
You can enjoy surround sound without disturbing sleeping children or neighbours.

Audio only

This control enables you to blank the TV picture if the TV or monitor is used as centre speaker in the Cinema Link system and if the audio receiver is reproducing sound unrelated to a TV picture.
Switch **Audio only On** to only hear the sound and to switch off the picture.
The message **Audio only** appears on screen.

Surround menu

Dependent on the audio receiver speakers configuration, you may not be able to select certain menu items.

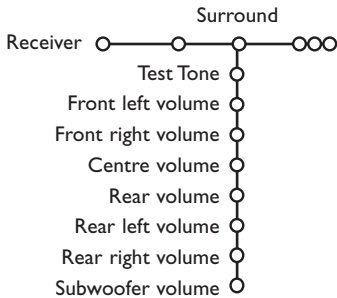

Adjustment of the volume level of the loudspeakers

Note: the test tone function is automatically cancelled by the audio receiver when leaving the Surround menu.

1 Select **Test Tone On**.

A steady noise tone is switched sequentially through the available loudspeakers, except for the subwoofer, for 2 seconds each. This enables you to have a reference of the loudness of each loudspeaker and to adjust the level of each until they all sound equally loud.

The loudspeakers activated light up in the screen graphic.

2 Select the Surround menu items with the cursor up/down one after another and alter the selected adjustments with the cursor left/right.

The best result is achieved when all speakers have equal volume in your usual listening position.

3 Select **Test tone Off** when you have finished the adjustment of the speaker levels.

Speakers menu

Dependent on the audio receiver speakers configuration, you may not be able to select certain menu items.

Once the number and position of the loudspeakers has been fixed, selecting Centre speaker, Rear Speakers and Subwoofer Yes or No, you can adjust the initial receiver settings, size and distance, for optimal surround sound.

Note: after changing the configuration, the menu will disappear temporarily and re-appear again after the new settings will be updated.

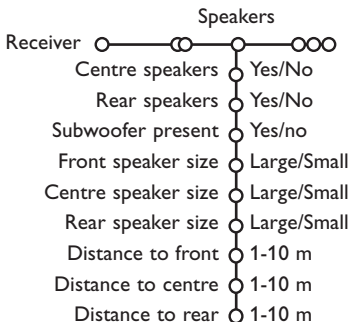

Size of the speakers

Select **Small** if your speaker is able to reproduce low notes down to at least 80-100 Hz. Select **Large** if your speaker is able to reproduce low notes down to at least 50 Hz.

Note:

- As a rule of thumb, a large speaker has a cone diameter of at least 12 cms (5 inches). See the specification sheet of your loudspeakers.
- If Subwoofer present is set to No, Front speaker size can only be set to Large. If Front speaker size is set to Small, Centre speaker size can only be set to Small and consequently a subwoofer must be connected.

Distance to the speakers

Select the distance from your usual listening position to the available speakers each; front, centre and rear speakers.
This defines the delay time for the surround sound.

Automatic installation

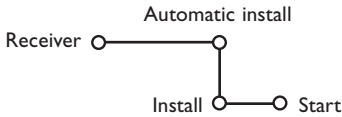

In the Automatic installation menu select **Start** to activate the automatic searching of all radio stations which can be received.

The programme list is automatically filled with all the numbers and names of the radio stations transmitted.

Manual installation

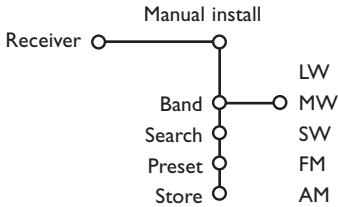

You can also search for a known radio station by keying in the frequency.

- 1 First select **Band** to switch to the desired waveband: **LW, MW, SW, FM** or **AM**.
- 2 Select **Search** and press the cursor right. The frequency increases until a radio station is found. If you know the 3-digit frequency, enter it directly with the digit keys 0 to 9. Select **Preset** to enter the preset number using a three digit entry with the digit keys.
- 3 To store your radio station, select **Store** and press the **OK** key.
- 4 Repeat steps 1 to 3 to store another radio station.

Give name - Reshuffle

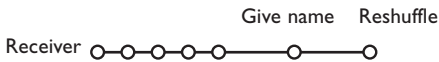

To assign or change a name to a radio station or to change the order of the stored radio stations according to your preference, act in the same way as with giving a name or reshuffling the programme list of TV channels. See the Instructions for Use of the TV or receiver box.